

Duravit NYC
105 Madison Avenue
New York, NY 10016
Toll Free 888-DURAVIT
Phone 212-686-0033
Fax 212-686-8033
info@us.duravit.com
www.duravit.nyc

Duravit USA, Inc.
2205 Northmont Pkwy., Ste. 200
Duluth, GA 30096
Toll Free 888-DURAVIT
Phone 770-931-3575
Fax 770-931-8454
info@us.duravit.com
www.duravit.us

Leben im Bad
Living bathrooms



D-Code

Duravit Showrooms: Hornberg and Meißen (Germany), Paris (France), Milan (Italy), New York (USA), Cairo (Egypt), Bizerte (Tunisia) and Shanghai (China). More Infos? www.duravit.us/showrooms

We reserve the right to make technical improvements and enhance the appearance of the products shown.



D-Code. The key to elegance in the bathroom. Of course, good design isn't everything, but a well-designed object makes life more pleasant. Even more so if it is affordable. D-Code by Duravit is a new kind of bathroom range – complete from washbasin to towel rail, consistently designed throughout and with an excellent value. Its appearance is restrained, featuring rectangular forms with rounded edges – the classic washbasin shape, in fact, that does not impose itself but rather blends with its surroundings. This is what makes D-Code so timelessly modern – a hallmark of good design. With alternatives and solutions for all imaginable bathroom situations, D-Code is a bathroom range that many people have been waiting for – including you, perhaps?

D-Code. La clef d'une belle salle de bains. Un bon design ne fait certainement pas tout. Mais les choses bien faites rendent malgré tout la vie bien plus agréable. Encore mieux si le design de qualité n'est maintenant plus hors de prix mais bien à portée de tous les budgets : Duravit présente avec D-Code une collection pour la salle de bains comme on n'en avait encore jamais vue – complète depuis le lavabo jusqu'au porte-serviettes, le tout comme sorti d'un même moule et d'un rapport qualité / prix plus que réjouissant. D-Code se fait discret – un rectangle aux angles arrondis –, tout bonnement la forme première du lavabo. Les formes discrètes n'essaient pas de se faufiler au devant de la scène, mais se fondent plutôt dans l'ambiance de chaque salle de bains. C'est ce qui rend D-Code tellement contemporain et classique ; ce qui est encore la caractéristique d'un bon design. Avec des variantes et des modèles pour toutes les circonstances imaginables, D-Code est vraiment le programme de salle de bains que beaucoup attendaient depuis longtemps. Vous aussi peut-être ?

D-Code. La clave para un baño más bello. Lo que es cierto es que un buen diseño no lo es todo. Sin embargo objetos bien diseñados convierten la vida en más agradable. Mejor aún si el buen diseño ya no es inaccesiblemente caro sino que es posible para un presupuesto asequible. Duravit presenta con D-Code una completa serie de baño nunca antes vista, que abarca de todo desde el lavabo hasta el toallero con un diseño único y con una muy buena relación calidad – precio. El aspecto de D-Code es reservado, un rectángulo con esquinas redondeadas, la forma elemental del lavabo. La forma discreta no destaca sino que se integra en el ambiente correspondiente. Esto convierte a D-Code en una serie intemporalmente moderna que es una de las características para un buen diseño. Con versiones y soluciones para cualquier situación del baño, D-Code es un programa que muchos esperaban, tal vez también usted.



Design by sieger design

14 1/8"
07053600002
07053600082
07053600092



19 5/8"
07065000002
07065000082
07065000092



17 3/4"
07054500002



21 1/2"
0337540000
0337540030



21 5/8"
23105500002
23105500302



23 5/8"
23106000002
23106000302



25 5/8"
23106500002
23106500302

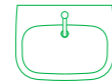

21 5/8"
0339550000
0339550030



19 1/2"
0338490000



22"
0338560000

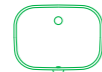

25 5/8"
03426500002
03426500302



+ # 0030321000

33 1/2"
03428500002
03428500302

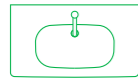

+ # 0030361000

41 3/8"
03421000002
03421000302

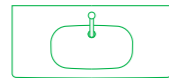

+ # 0030351000

47 1/4"
03481200002
03481200302

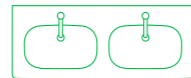

+ # 0030331000

0113010001
0113010082



+ # 0067410000/
0062090096

0117010062

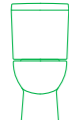

+ # 0067410000/
0062090096
+ # 0927200002

21420900922



+ # 0067410000/
0062090096
+ # 0927100004

25350900922



+ # 0067310000/
0067390000

22381000002



59" x 29 1/2"
700095



63" x 27 1/2"
700096

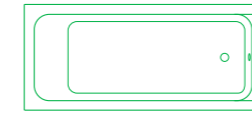

66 7/8" x 29 1/2"
700100

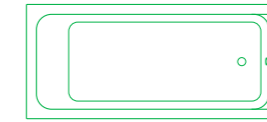

70 7/8" x 31 1/2"
700101

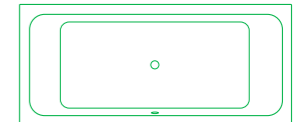

60" x 32"
700405

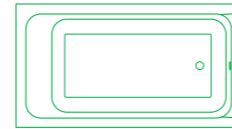

60" x 32"
700406

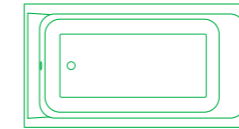



2310600002

Long live variety. The classic washbasin is available in a width of 21 5/8", 23 5/8" and 25 5/8", with or without a siphon cover. The handrinse basin with a width of 14 1/8", 17 3/4" or 19 5/8" is a practical addition. The furniture washbasin, with a width of 25 5/8", 33 1/2" or 41 3/8", offers a great deal of counterspace. The double washbasin (47 1/4") is available with or without a siphon cover or as a furniture washbasin. The vanity basins allow for custom combinations for drop-in installation (21 1/2" x 17 1/8") or undermounted (19 1/2" x 11 3/8" or 22" x 15 3/4"). D-Code truly offers an attractive solution for every bathroom.

Vive la variété. Le lavabo classique est disponible dans les largeurs 21 5/8", 23 5/8" ou 25 5/8", et pour chaque largeur, avec ou sans cache-siphon. Le lave-main dans les largeurs 14 1/8", 17 3/4" ou 19 5/8" constitue un complément pratique. Le lavabo pour meuble dans les largeurs 25 5/8", 33 1/2" ou 41 3/8" offre une grande surface de dépose. Le grand lavabo double (47 1/4") peut être livré avec ou sans cache-siphon ou en version lavabo pour meuble. La vasque encastrée, à monter par le haut (21 1/2" x 17 1/8") ou par le bas (19 1/2" x 11 3/8" ou 22" x 15 3/4"), permet de créer des combinaisons personnalisées. D-Code offre une solution esthétique pour absolument toutes les salles de bains.

Mucha diversidad es el lema. El lavabo clásico está disponible en anchos de 21 5/8", 23 5/8" o 25 5/8" con o sin semipedestal. Un complemento práctico es el lavamanos de ancho 14 1/8", 17 3/4" o 19 5/8". El lavabo para mueble con anchos de 25 5/8", 33 1/2" o 41 3/8" ofrece mucho espacio para almacenar. El lavabo doble (47 1/4") está disponible con o sin semipedestal o como lavabo para mueble. Los lavabos empotrados desde arriba (21 1/2" x 17 1/8") o desde abajo (19 1/2" x 11 3/8" o 22" x 15 3/4") permiten diferentes combinaciones individuales.



03481200002

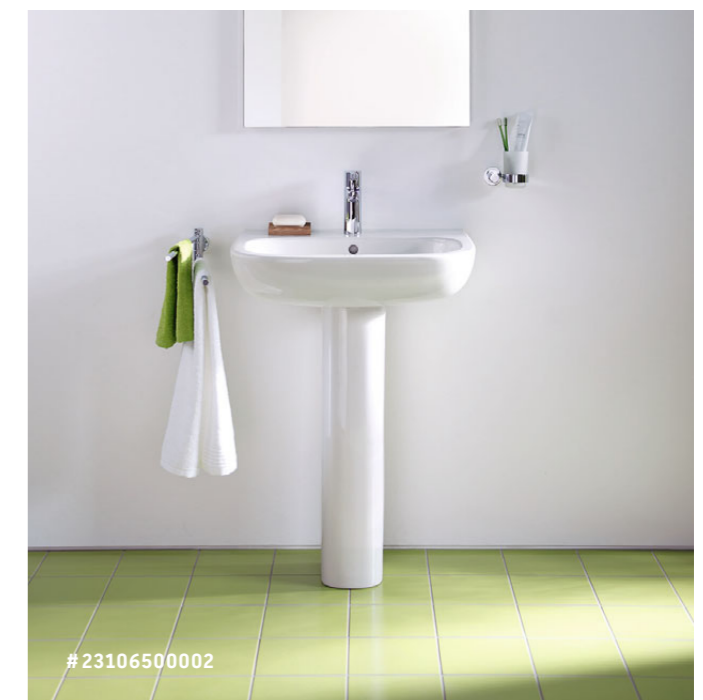

23106500002







D-Code 25 5/8" # 03426500002
 Delos 23 5/8" # DL 6334 0 12 12



One solution for everything. The D-Code furniture washbasin, available in widths 25 5/8", 33 1/2", 41 3/8" and 47 1/4", the latter of which features a double basin, offers the perfect seamless washbasin solution. It can be combined with various vanity units from the Duravit DuraStyle, Ketho, X-Large and Delos furniture ranges to yield a harmonious, cozy unit, with the high level of quality you expect from Duravit as an experienced producer of bathroom furniture.

Une solution tout-en-un. Le lavabo pour meuble D-Code offre une solution de plan de toilette idéale, d'un seul bloc, et est disponible dans les largeurs 25 5/8", 33 1/2", 41 3/8" and 47 1/4", avec pour cette dernière largeur, deux lavabos. Il se combine avec les différents meubles de dessous, issus des gammes de meubles Duravit DuraStyle, Ketho, X-Large et Delos. Il en résulte un ensemble harmonieux et confortable. Le tout bien sûr dans la grande qualité habituelle, offerte par le fabricant expérimenté de mobilier de salle de bains Duravit.

Uno para todo... Una compacta solución para un puesto de aseo ofrece el lavabo para mueble D-Code que está disponible en la versión con ancho de 25 5/8", 33 1/2", 41 3/8" and 47 1/4" y este último con dos senos. Este puede ser combinado con diferentes muebles lavabos del programa de muebles DuraStyle, Ketho, X-Large y Delos de Duravit. De esta manera se forma un conjunto armónico y confortable. Y todo esto naturalmente con la alta calidad que estamos acostumbrados de Duravit como fabricante de muebles.



D-Code and Delos: The handle-free vanity units can be opened with a push-open mechanism.

D-Code et Delos : Les meubles sous-lavabo sans poignée s'ouvrent au moyen de la technologie tip-on.

D-Code y Delos: Mueble para lavabo sin tirador que se abre mediante la técnica Tip-on.



D-Code and Ketho: Stylish surfaces, enormous storage space, enormous possibilities. And all without a sleek appearance.

D-Code et Ketho : Surfaces élégantes, espace de rangement plus que généreux, possibilités multiples. Et tout cela, sans effet de lourdeur.

D-Code y Ketho: Un acabado moderno, mucho espacio para almacenar con muchas posibilidades. Y todo con una apariencia de ligereza.



49 - Graphite Matt



51 - Pine Terra



52 - European Oak



53 - Chestnut Dark



73 - Ticino Cherry Tree



79 - Natural Walnut



14 - Terra



18 - White Matt



22 - White High Gloss



31 - Pine Silver



43 - Basalt Matt



3 3/8" # 03428500002



D-Code 33 1/2" # 03428500002
 DuraStyle 31 1/2" # DS 6484 0 52 52

D-Code and DuraStyle: Additional furniture solutions to provide storage space.

D-Code et DuraStyle : Des solutions avec meubles qui permettent beaucoup de rangement.

D-Code con DuraStyle: Soluciones adicionales para ofrecer espacio para guardar.



49 - Graphite Matt



51 - Pine Terra



52 - European Oak



53 - Chestnut Dark



73 - Ticino Cherry Tree



79 - Natural Walnut



14 - Terra



18 - White Matt



22 - White High Gloss



31 - Pine Silver



43 - Basalt Matt

D-Code and X-Large: Clear, sophisticated, cozy.

The ergonomically designed handles are particularly characteristic of these ranges.

X-Large is available in 30 different colors, see p. 31

D-Code et X-Large : Clair, bien pensé, confortable.

Détail particulièrement caractéristique :

les poignées-baguettes ergonomiques. X-Large est disponible en 30 finitions différentes voir p. 31

D-Code e X-Large: Nítido, estudiado y confortable.

Sobre todo el característico tirador de forma ergonómica. X-Large está disponible en 30 colores diferentes, ver pág. 31



22 - White High Gloss



49 - Graphite Matt



12 - Brushed Oak



72 - Brushed Dark Oak



D-Code 41 3/8" # 03421000002
X-Large 39 3/8" # XL 6049 0 72 72



The choice is yours. After all, every bathroom user should be able to find exactly the product needed for his or her project, be it an apartment or multi-family dwelling, an office or a hotel, a private, semi-public or open area. Choices range from the wall-mounted toilet to a variety of floor standing models. The D-Code One-Piece toilet is available with a left and right hand flush lever and complies with North American ADA standards.

Vous avez le choix. En fin de compte, chaque utilisateur de salle de bains doit pouvoir trouver exactement le produit qu'il lui faut pour son projet, qu'il s'agisse d'un appartement en copropriété ou d'un immeuble collectif, d'un bureau ou d'un hôtel, qu'il soit privé, semi-public ou public. Vous avez le choix entre la cuvette suspendue et différentes cuvettes sur pied. La cuvette D-Code One-piece est disponible avec levier à gauche ou à droite et accompli avec les standards d'Amérique du Nord ADA.

Puede elegir. Al fin y al cabo cada usuario quiere encontrar exactamente el producto que necesita para su proyecto, sea un piso de propiedad o una casa adosada, unas oficinas o un hotel y tanto para el uso privado, semipúblico o público. Puede elegir entre un inodoro suspendido, el inodoro suspendido en versión Compact (con fondo hondo) y el inodoro de pie (con fondo hondo y plano) complementado en cada caso por el correspondiente bidé.



2238100002

0113010001



0113010001 One-Piece version

# 0117010062 Two-Piece version
0927200002

Bubbles, water, warmth, wellbeing – there's nothing like a hot bath. But it's even more enjoyable if you can stretch out in a genuine designer bathtub. D-Code makes this extravagant luxury affordable with an elegant selection of bathtubs to match the rest of the range, at a genuine entry-level price. There is only one thing that money can't buy – the peace, relaxation and comfort to be found in D-Code bathtubs. There are six models to choose from, including an integrated tile flange version.

De la mousse, de l'eau, de la chaleur et une sensation de bien-être - rien n'est plus agréable que de prendre un bain bien chaud. Mais c'est tout de même un petit peu plus agréable quand on peut se prélasser dans une véritable baignoire design. D-Code rend ce luxe apparemment inaccessible tout à fait abordable. Les belles lignes de son assortiment de baignoires à de véritables prix d'entrée de gamme, sont assorties au design de la collection. Une seule chose reste irremplaçable : c'est le calme, la détente et le confort que l'on peut trouver dans une baignoire D-Code. L'assortiment comprend 6 modèles différents de baignoires, une version avec band isolant inclus.

Espuma, agua, calor y bienestar - No hay nada como un baño caliente. Mejor aún si este lo podemos disfrutar en una auténtica pieza de diseño. D-Code hace económicamente accesible este lujo aparentemente inalcanzable. Con un programa de bellas bañeras con una excelente relación calidad - precio que además está coordinado con las demás series en cuanto a diseño. Solo una cosa no se puede pagar: el silencio, la relajación y la comodidad que puede encontrar en una bañera D-Code. Hay seis modelos para elegir, incluyendo una versión con perfil de pared integrado.



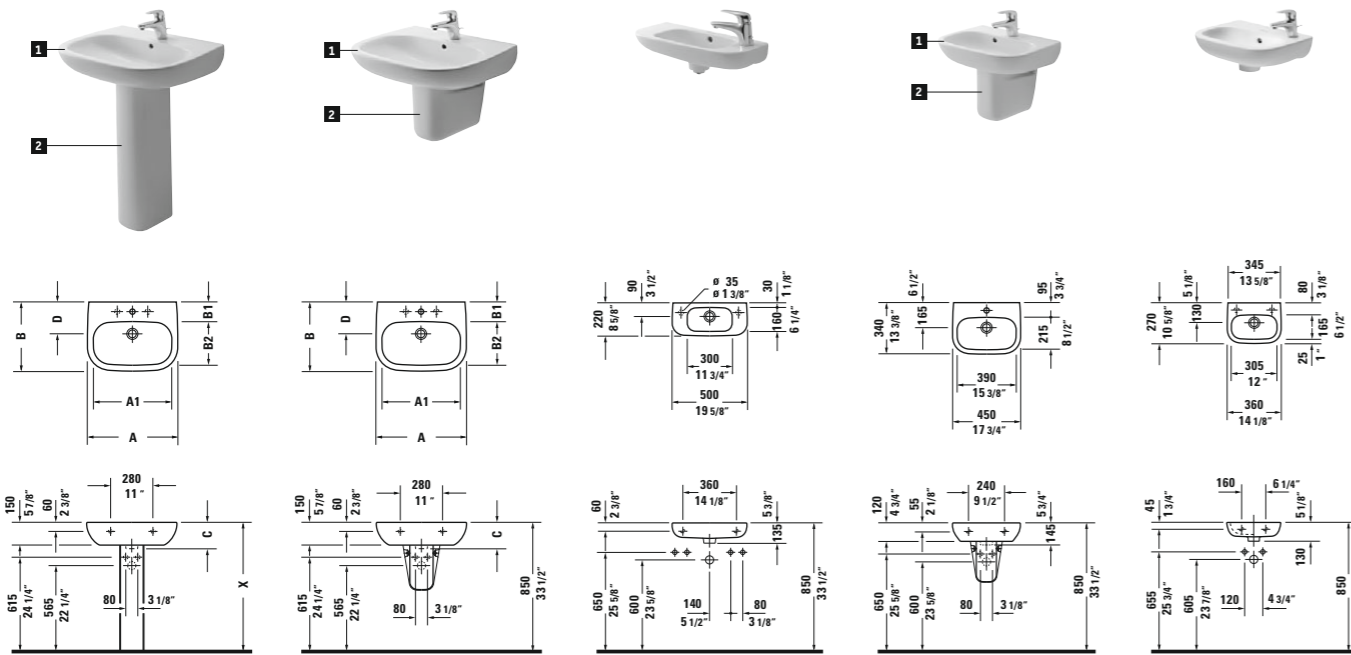

| | A | A1 | B | B1 | B2 | C | D |
|--------|---------|---------|---------|--------|---------|--------|--------|
| 231065 | 25 5/8" | 22 1/4" | 19 5/8" | 5 1/8" | 12 3/4" | 7 1/8" | 8 1/8" |
| 231060 | 23 5/8" | 20 1/2" | 18 1/8" | 5 1/8" | 11 3/8" | 6 7/8" | 8 1/8" |
| 231055 | 21 5/8" | 18 3/4" | 16 7/8" | 5 1/8" | 4 1/2" | 6 7/8" | 8 1/4" |

- # 23106500002 ●
- # 23106500302 ● ● ● ●
- # 23106000002 ●
- # 23106000302 ● ● ● ●
- # 23105500002 ●
- # 23105500302 ● ● ● ●
- # 08632700002

- # 23106500002 ●
- # 23106500302 ● ● ● ●
- # 23106000002 ●
- # 23106000302 ● ● ● ●
- # 23105500002 ●
- # 23105500302 ● ● ● ●
- # 08571800002

- # 07065000002 ☒
- # 07065000082 ● (r)
- # 07065000092 ● (l)

- # 07054500002 ●
- # 08571700002

- # 07053600002 ☒
- # 07053600082 ● (r)
- # 07053600092 ● (l)

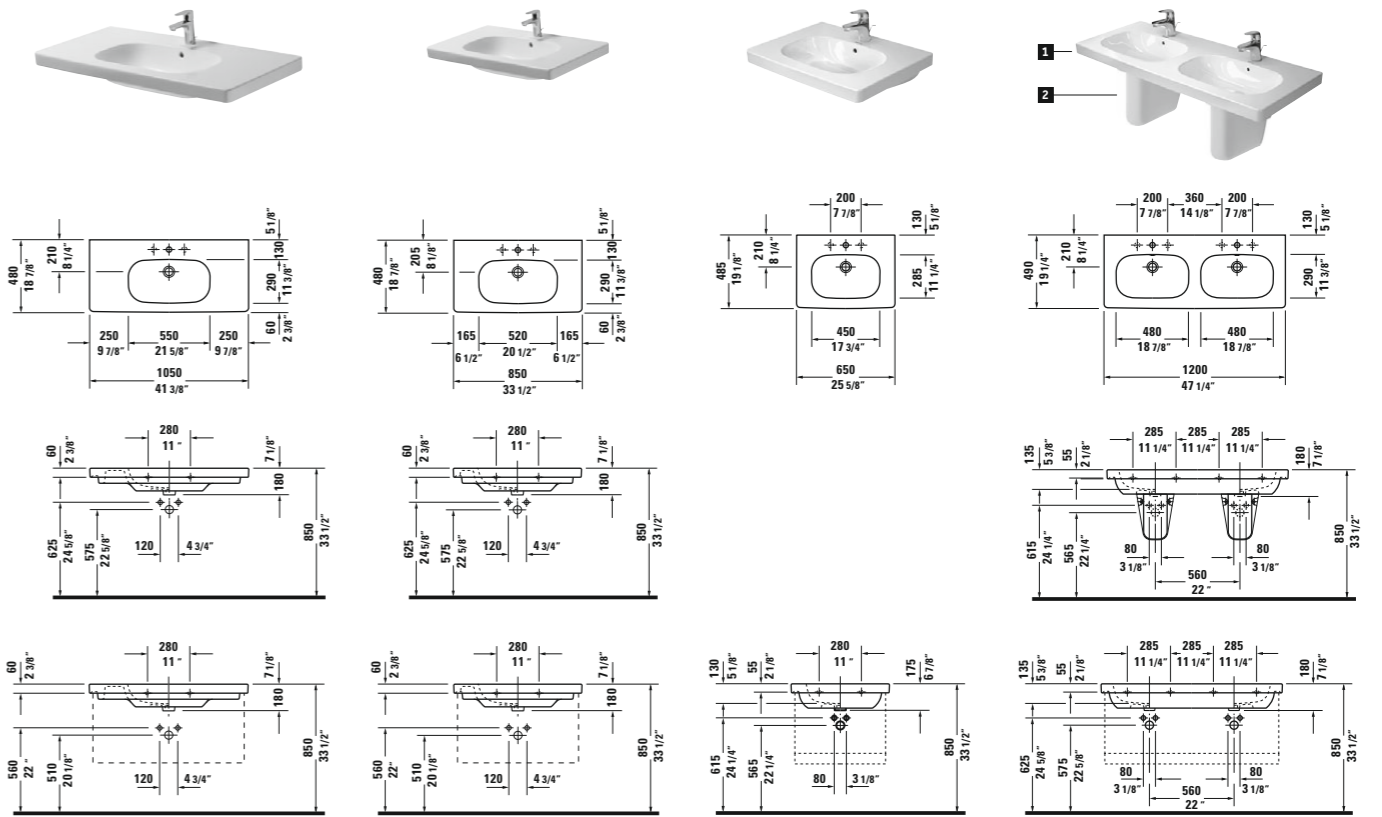

- # 03421000002 ● ● ● ● ●
- # 03428500002 ● ● ● ● ●
- # 03426500002 ● ● ● ● ●
- # 03426500302 ● ● ● ● ●

- # 03481200002 ● ● ● ● ●
- # 03481200302 ● ● ● ● ●
- # 08571800002

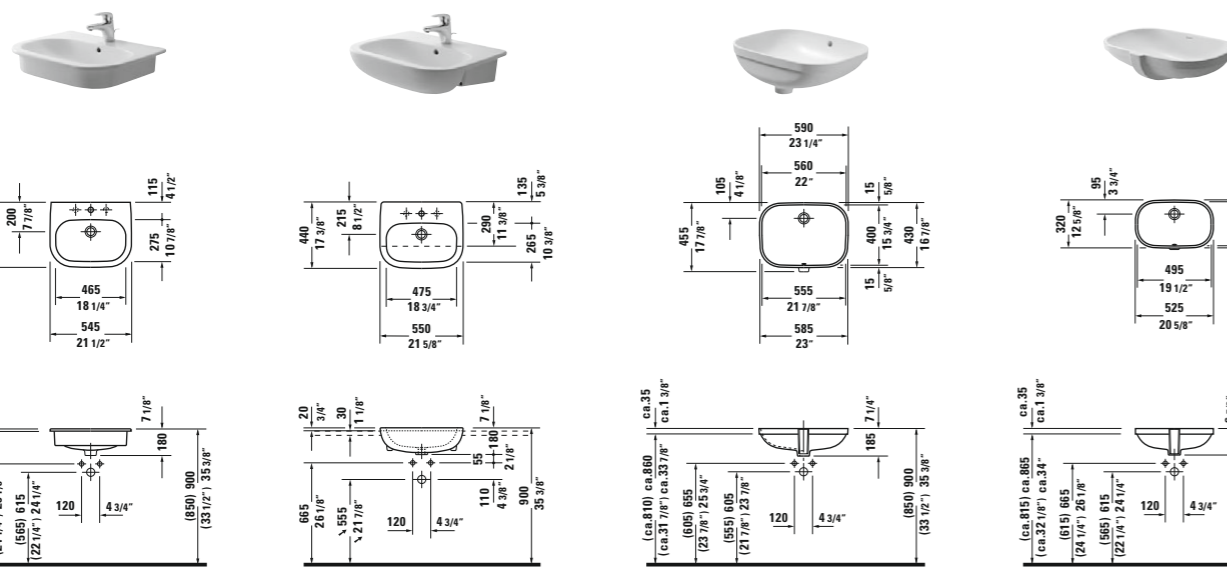

- # 0337540000 ● ● ● ● ●
- # 0337540030 ● ● ● ● ●

- # 0339550000 ● ● ● ● ●
- # 0339550030 ● ● ● ● ●

- # 0338560000 ☒ ● ● ● ● ●

- # 0338490000 ☒ ● ● ● ● ●

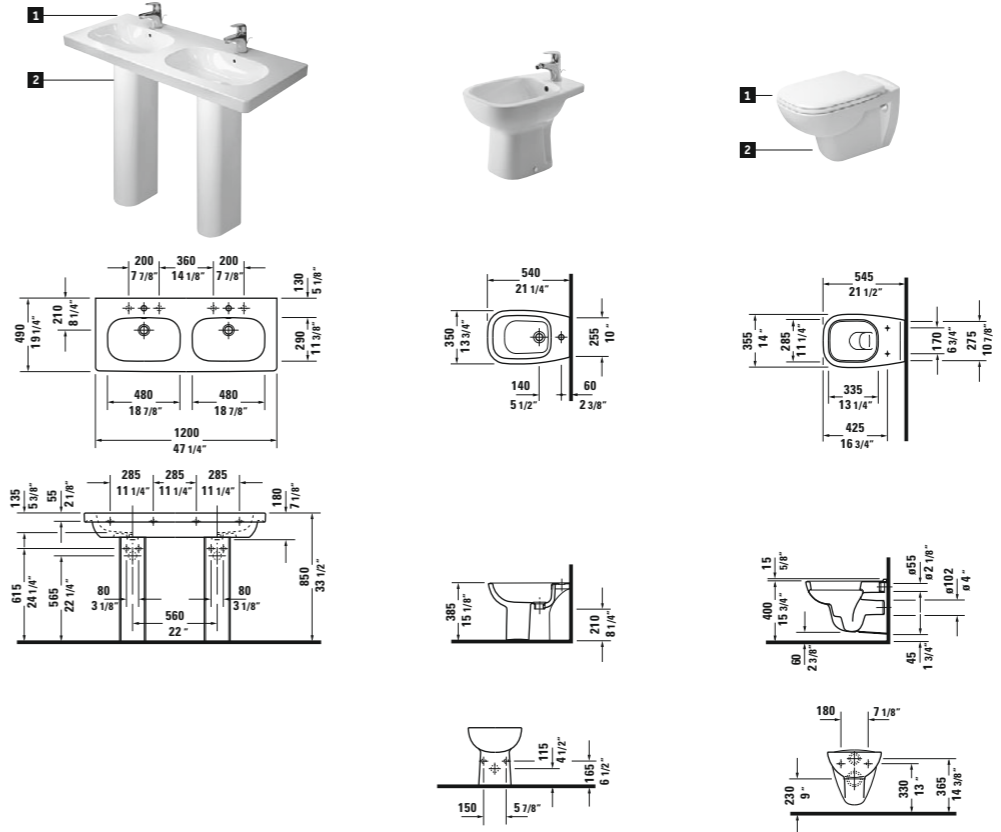

- # 03481200002 ● ● ● ● ●
- # 03481200302 ● ● ● ● ●
- # 08632700002

- # 22381000002 ● ● ● ● ●

- # 0067310000 ● ● ● ● ●
- # 0067390000 ● ● ● ● ●
- (Soft-close)
- # 25350900922 ● ● ● ● ● 1.6/0.8 gpf ☑

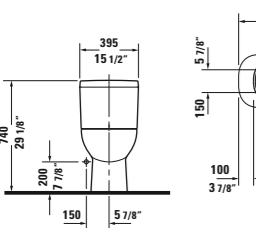
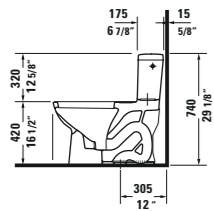
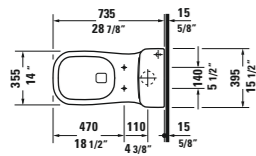

- 1 # 0067410000
- # 0062090096 (Soft-close)
- 2 # 0113010001 1.28 gpf (side lever left)
- # 0113010082 1.28 gpf (side lever right)

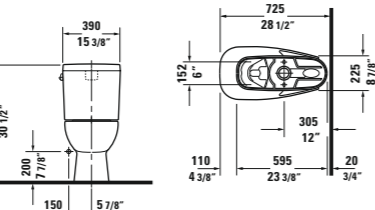
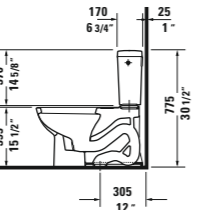
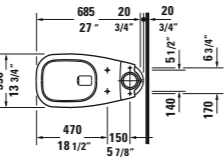

- 1 # 0067410000
- # 0062090096 (Soft-close)
- 2 # 0117010062 1.28 gpf
- # 0927200002

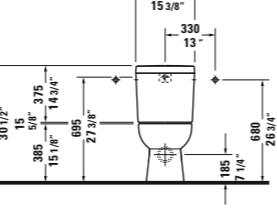
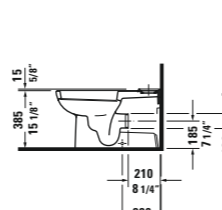
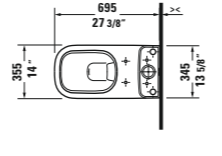

- 1 # 0067410000
- # 0062090096 (Soft-close)
- 2 # 21420900922 1.6/0.8 gal
- # 0927200004

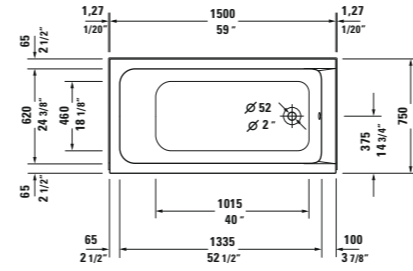

- # 700095 00 0 00 0093**
- 59 1/8" x 29 1/2"
- Metal flange left
- # 700095 00 0 00 0094**
- 59 1/8" x 29 1/2"
- Metal flange right
- Built-in. Version à encastrer.
- Versión empotrada

- # 700095 00 0 00 0093**
- 59 1/8" x 29 1/2"
- Metal flange left
- # 700095 00 0 00 0094**
- 59 1/8" x 29 1/2"
- Metal flange right
- With optional bathtub panel. Avec tabelier en option. Con faldón opcional *

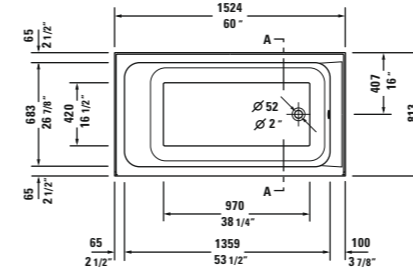
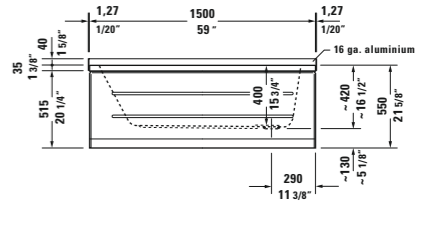
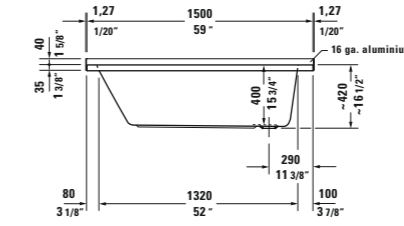

- # 700405 00 0 00 0090
- 60" x 32"
- With integrated tile flange
- Built-in. Version à encastrer.
- Versión empotrada

- # 700405 00 0 00 0090
- 60" x 32"
- With integrated tile flange
- With optional bathtub panel. Avec tabelier en option. Con faldón opcional *

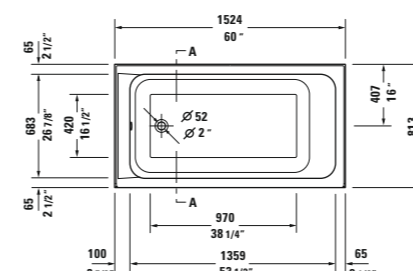
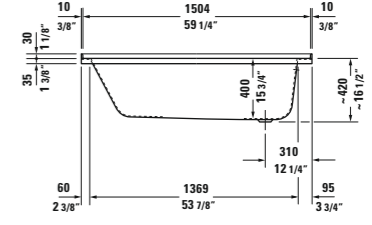
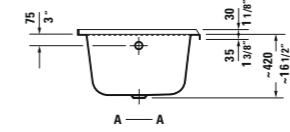

- # 700406 00 0 00 0090
- 60" x 32"
- With integrated tile flange
- Built-in. Version à encastrer.
- Versión empotrada

- # 700406 00 0 00 0090
- 60" x 32"
- With integrated tile flange
- With optional bathtub panel. Avec tabelier en option. Con faldón opcional *

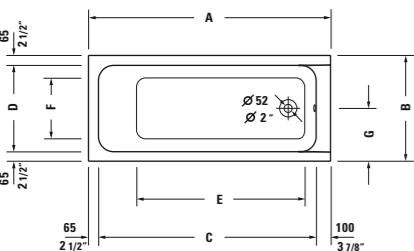
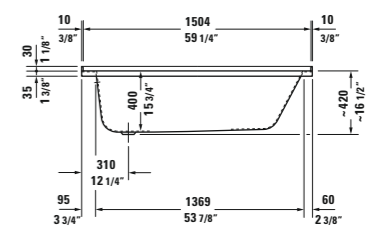
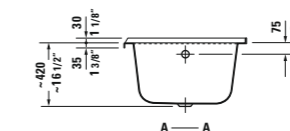

- # 700095 00 0 00 009X*
- 59 1/8" x 29 1/2"
- # 700096 00 0 00 009X*
- 63" x 27 1/2"
- # 700100 00 0 00 009X*
- 66 7/8" x 29 1/2"
- Built-in. Version à encastrer.
- Versión empotrada

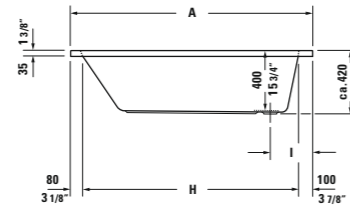

- # 700095 00 0 00 009X*
- 59 1/8" x 29 1/2"
- # 700096 00 0 00 009X*
- 63" x 27 1/2"
- # 700100 00 0 00 009X*
- 66 7/8" x 29 1/2"
- With optional bathtub panel. Avec tabelier en option.
- Con faldón opcional *

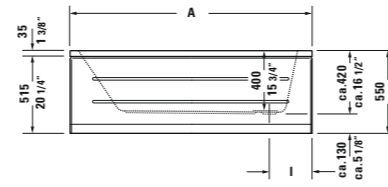

| | A | B | C | D | E | F | G | H | I |
|--------|---------|---------|---------|---------|---------|---------|---------|---------|---------|
| 700095 | 59" | 29 1/2" | 52 1/2" | 24 3/8" | 40 1/8" | 18 1/8" | 14 3/4" | 52" | 10 3/4" |
| 700096 | 63" | 27 1/2" | 56 1/2" | 22 1/2" | 43 7/8" | 15 3/4" | 13 3/4" | 55 7/8" | 11" |
| 700100 | 66 7/8" | 29 1/2" | 60 3/8" | 24 3/8" | 47 1/4" | 16 7/8" | 14 3/4" | 59 7/8" | 11" |

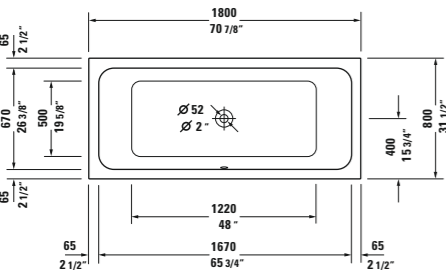

- # 700101 00 0 00 009X*
- 70 7/8" x 31 1/2"
- Built-in. Version à encastrer.
- Versión empotrada

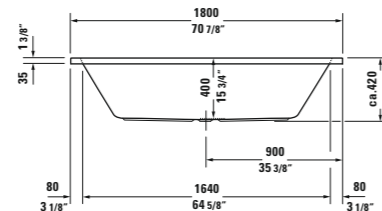

- # 700101 00 0 00 009X*
- 70 7/8" x 31 1/2"
- With optional bathtub panel. Avec tabelier en option.
- Con faldón opcional *

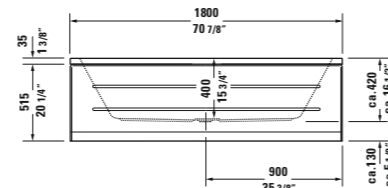

* Suitable bathtub panels see current pricelist. Habillages de baignoire correspondants, voir le tarif en vigueur. Para los correspondientes faldones, por favor mire la lista de precios general en vigor.

* 90-Version: Minimum order qty. = 10 pcs. / 92-Version: Individually packed. No minimum order qty.
 ** Minimum order qty. = 35 pcs. Left and right drain version may be combined for quantity requirement.

Most D-Code bathtubs are available with a whirlsystem. See current price list for further information.
 Les Plus les baignoires D-Code sont disponibles avec un système Jet special. Pour de plus amples informations, voir le tarif en vigueur.
 Más las bañeras D-Code están disponibles con un sistema de hidromasaje. Para más información mire la lista de precios actual.

Symbols

- X To determine height please set washbasin on pedestal. Définir les dimensions exactes par rapport au positionnement de la colonne
La altura de fijación se determina poniendo el pedestal por debajo del lavabo
- ~ With usage of design siphon. Pour l'utilisation du siphon design. Utilizando el sifón de diseño
- ⊗ Without tap hole. Sans trou. Sin agujero para grifería
- 1 tap hole punched. 1 trou percé. 1 agujero para grifería hecho
- 3 tap holes punched. 3 trous percés. 3 agujeros hechos
- (r) Right. Droite. Derecha
- (l) Left. Gauche. Izquierda
- ⌵ Installation from above. Montage par-dessus. Montaje desde arriba
- ⌴ Installation from below. Montage par dessous. Montaje desde arriba
- Vertical outlet. Sortie verticale. Desagüe vertica
- Desagüe horizontal. Horizontal outlet. Sortie horizontale
- 💧 Water saving 6-liter flush. Accompagne les WC's et réservoirs, permettant un rinçage économique de 6 litres
Para inodoros y cisternas con un lavado de 6 litros
- ➔ Side supply, left. Alimentation latérale à gauche. Cisterna, alimentación lateral, izquierda
- ➜ Side supply, right. Alimentation latérale à droite. Cisterna, alimentación lateral, derecha
- ➔➜ Back supply. Alimentation arrière. Cisterna alimentación posterior
- ⌵ Bottom left supply. Alimentation dessous gauche. Cisterna alimentación inferior izquierda

Colors

Decor for DuraStyle, Ketho, Delos & X-Large

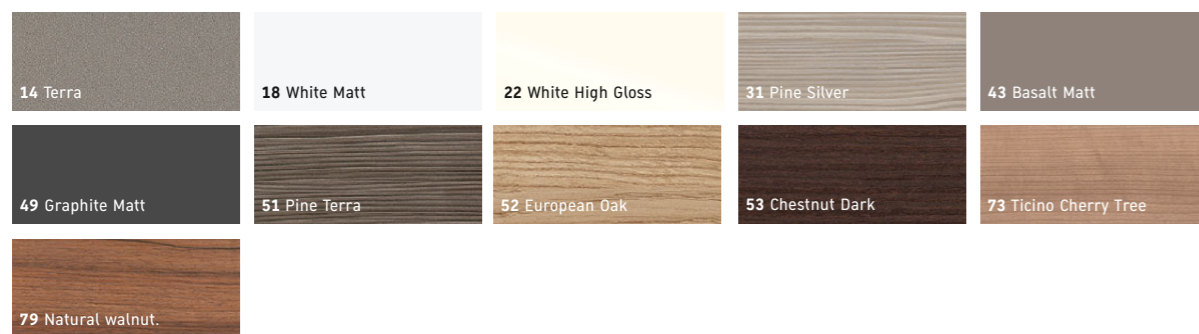

Real Wood veneer for Delos & X-Large

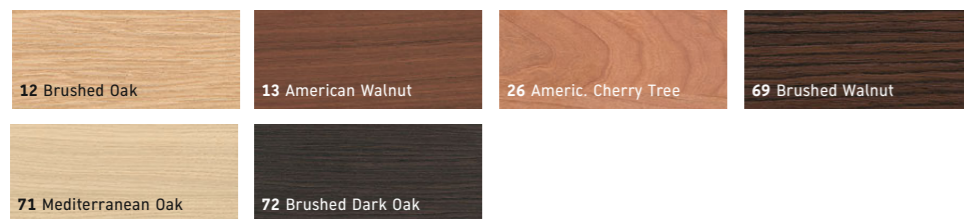

Lacquer for Delos & X-Large

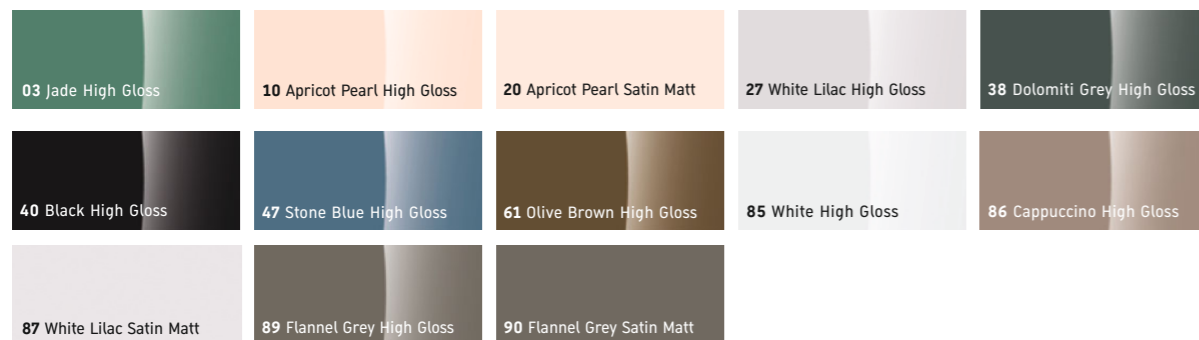

We reserve the right to make technical improvements and enhance the appearance of the products shown.
Nous nous réservons le droit d'apporter des améliorations techniques et de modifier l'apparence visuelle des produits présentés.
Nos reservamos el derecho de realizar modificaciones técnicas y de aspecto de los productos representados.